

PixLite® T8-S Mk2

LONG RANGE TRANSMITTER



DATASHEET

PIXLITE T8-S Mk2 KEY FEATURES

SEND DATA UP TO 300M TO RECEIVERS

96 UNIVERSES OF Art-Net OR sACN

OVER 50+ PIXEL PROTOCOLS SUPPORTED

ELECTRICAL FAULT PROTECTION ON ALL PORTS



Get the latest datasheet, user manuals, firmware updates, and more from

www.advateklights.com
support@advateklights.com

ADVATEK

PixLite® is a registered trademark

PixLite® T8-S Mk2

LONG RANGE TRANSMITTER

PRODUCT OVERVIEW

The PixLite T8-S Mk2 is a pixel LED controller that's built to last and has all the protection one needs for peace of mind with professional installations

The PixLite T8-S Mk2 transmits up to 96 universes of data to 8 PixLite R2/R4 devices at distances up to 300m. Perfect for any professional installation, particularly when the LEDs will be separated by some distance.

A CLOSER LOOK AT THE CONTROLLER

Art-Net

Supports Art-Net versions 1 to 4 for great compatibility with many lighting systems.

STREAMING ACN

E1.31 supports unicast and multicast traffic. IGMP capability makes network setup for large sACN installations a breeze.

WIDE RANGE OF SUPPORTED PIXELS

Over 50+ protocols, including WS2801, WS2811/12/13/15/18, APA102/104, TM180x, SK6812/6822, MY9221/9231, plus many more.

[See full list of pixel protocols here](#)

FAULT PROTECTION

Features electrical fault protection on all differential data outputs, resulting in higher reliability and less equipment failures over time. See details on next page.

EXTREME FLEXIBILITY

Expanded mode option for data-only pixels offers twice as many digital outputs for faster refresh rates and greater flexibility. Clocked pixel types have **adjustable speeds**, allowing you to optimize refresh rate with cable length limitations. Advanced mapping options are available on every output: Null Pixels | Zig-zag | Reversing | Color Order | Pixel Grouping | Brightness Limiting.

COMPATIBLE RECEIVERS:

PixLite R4D-S



PixLite R2F-S



OPTIONAL ACCESSORIES

Single Unit Rack Mount Bracket (1RU)

Dual Unit Rack Mounting Kit (1RU)

Wall Bracket Mounting Kit

CONTENTS

PixLite T8-S Mk2

Power Cord (IEC C13)

Installation Guide



Get the latest datasheet, user manuals, firmware updates, and more from www.advateklights.com

support@advateklights.com

ADVATEK

PixLite® is a registered trademark

PixLite® T8-S Mk2

LONG RANGE TRANSMITTER

CONNECTIVITY

- 1 Status LED
- 2 Power LED
- 3 Test Button
- 4 System Button
- 5 8 x RJ45 Outputs (to PixLite Receivers)
- 6 Ethernet Port
- 7 AC Power Socket

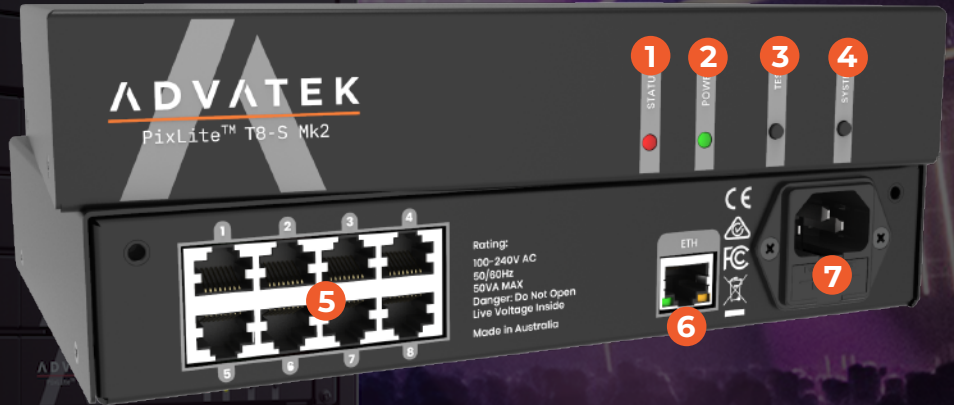

TECHNICAL SPECIFICATIONS

PHYSICAL

RJ45 Data Outputs	8
Ethernet Port	1 x 10/100 MBit/s
Dimensions	221 x 160 x 42 mm (L x W x H)
Rack Size	Half 19"x1U
Weight	1.06 kg
Enclosure	Textured Metal - Black
Ambient Operating Temperature	-10°C to +60°C
Mounting	Direct Panel, Wall & Rack Mountable

POWER

Input Power	100V - 240V AC
AC Fuse	1A M205 Glass

FAULT PROTECTION

Data Outputs	+/- 24V DC fault protection
ESD	Protection on all Data Outputs and Ethernet Port

PIXEL DATA

	NORMAL MODE	EXPANDED MODE
Pixel Outputs	16	32
RGB Pixels per Output	1020	510
RGBW Pixels per Output	768	384
Universes per Pixel Output	6	3
Total Pixel Universes	24	24

Get the latest datasheet, user manuals, firmware updates, and more from www.advateklights.com

support@advateklights.com

ADVATEK

PixLite® is a registered trademark

PixLite® T8-S Mk2

LONG RANGE TRANSMITTER

DIMENSIONS

OVERALL DIMENSIONS

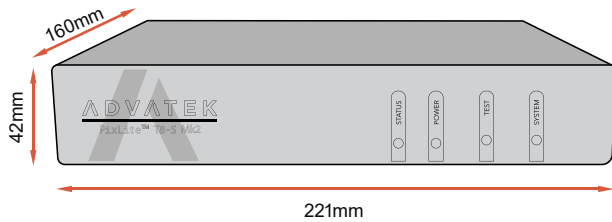

MOUNTING DIMENSIONS

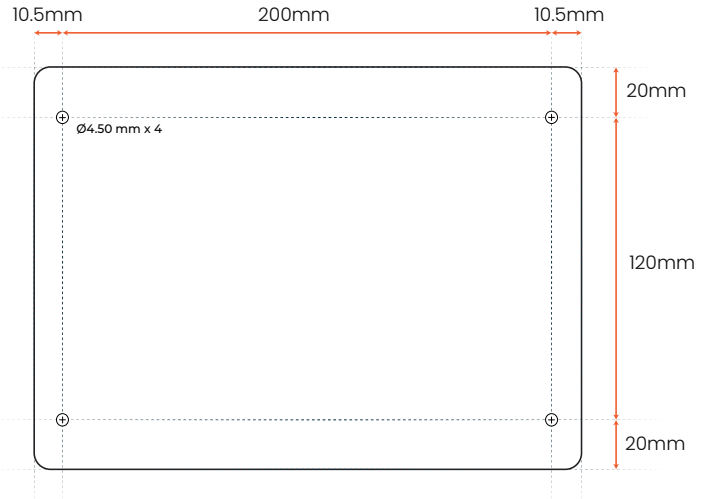

TYPICAL WIRING DIAGRAM

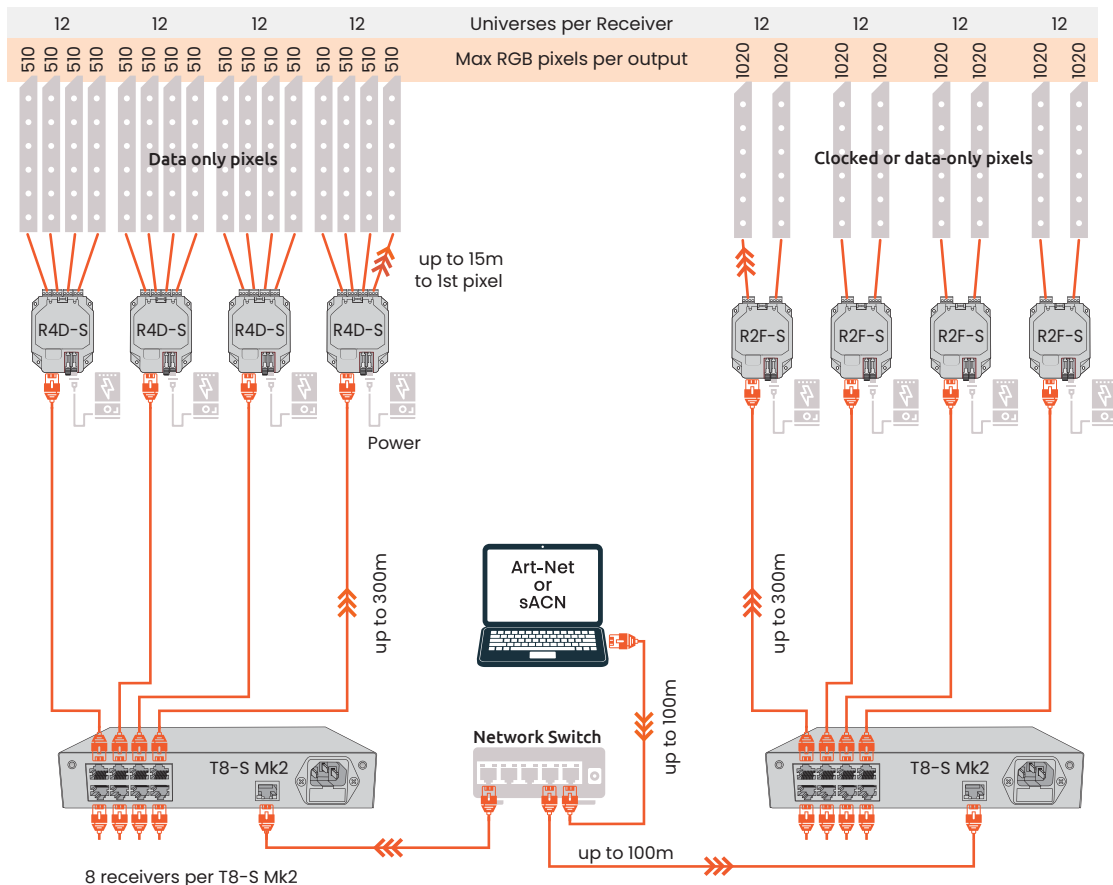

Get the latest datasheet, user manuals, firmware updates, and more from www.advateklights.com

support@advateklights.com

ADVATEK

PixLite® is a registered trademark

PixLite® T8-S Mk2

LONG RANGE TRANSMITTER

OPTIONAL MOUNT ACCESSORIES

WALL MOUNT



IU RACK - SINGLE



IU RACK - DUAL



POWER SOCKET OPTIONS

Type I

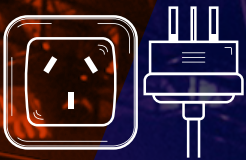

Type B

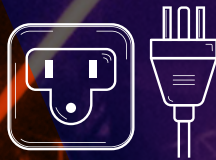

Type G

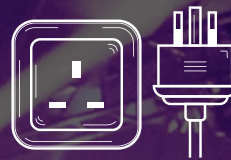

Type F



ORDER CODES

PHYSICAL

VARIANT

LOCATION

ORDER CODES

PixLite T8-S Mk2	Type I	Australia	PIXT8S2AU
PixLite T8-S Mk2	Type B	United States	PIXT8S2US
PixLite T8-S Mk2	Type G	United Kingdom	PIXT8S2UK
PixLite T8-S Mk2	Type F	Europe	PIXT8S2EU
Mounting Bracket	Wall		MNT0301
Mounting Bracket	IU Rack - Single		MNT0201
Mounting Bracket	IU Rack - Dual		MNT0202

Get the latest datasheet, user manuals, firmware updates, and more from www.advateklights.com

support@advateklights.com

ADVATEK

PixLite® is a registered trademark